

CT-S range Ordering details Accessories

Remote potentiometer

50 k Ω \pm 20 % - 0,2 Ω , degree of protection IP66

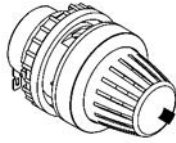

MT-x50B



30 mm adapters

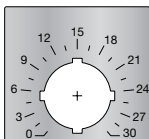
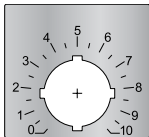
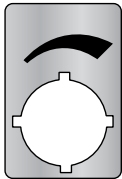

Marker label with scale 0-30
48.5 x 44.5 mm

| Material | Diameter | Reference code | Catalog number | Pack.-unit | Weight |
|-----------------|----------|----------------|-----------------|------------|--------|
| | in mm | | | | |
| Plastic, black | 22.5 | MT-150B | 1SFA611410R1506 | 1 | 0.040 |
| Plastic, chrome | 22.5 | MT-250B | 1SFA611410R2506 | 1 | 0.040 |
| Metal, chrome | 22.5 | MT-350B | 1SFA611410R3506 | 1 | 0.048 |

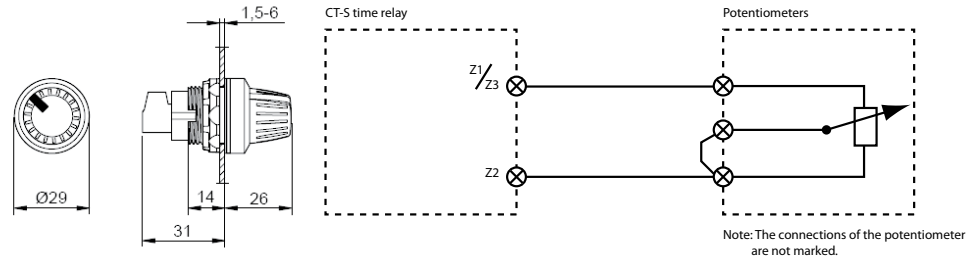

30 mm adapter for attaching the potentiometer 22 mm in 30 mm mounting hole

| Material | Reference code | Catalog number | Pack.-unit | Weight |
|----------------|----------------|-----------------|------------|---------|
| | | | pieces | 1 piece |
| Plastic, black | KA1-8029 | 1SFA616920R8029 | 1 | g / oz |
| Metal, chrome | KA1-8030 | 1SFA616920R8030 | 1 | |

Marker label

| Caption | Reference code | Catalog number | Pack.-unit | Weight |
|---------------------------|----------------|-----------------|------------|---------|
| | | | pieces | 1 piece |
| Symbol (see illustration) | SK 615 562-87 | GJD6155620R0087 | 1 | 0.002 |
| Scale 0 - 10 | SK 615 562-88 | GJD6155620R0088 | 1 | 0.002 |
| Scale 0 - 30 | MA16-1060 | 1SFA611940R1060 | 1 | 0.002 |

CT-S range Ordering details Accessories

Accessories

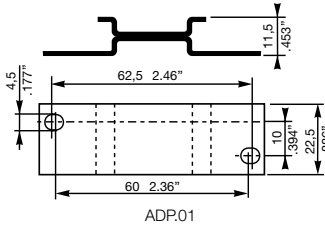

ADP.01

| Material | for devices | Reference code | Catalog number | Pack.-unit pieces | Weight 1 piece g / oz |
|--|------------------|----------------|-----------------|----------------------|-----------------------------|
| Adapter for screw mounting ¹⁾ | CT-S 22.5 mm | ADP.01 | 1SVR430029R0100 | 1 | 18.4/0.65 |
| Sealable transparent cover | | COV.01 | 1SVR430005R0100 | 1 | 5.2/0.18 |
| Sealable transparent cover ¹⁾ | CT-S.S/P 22.5 mm | COV.11 | 1SVR730005R0100 | 1 | 4 / 0.129 |

Marker label

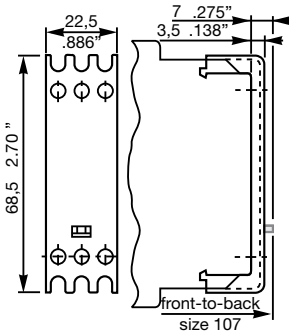

COV.01

| Material | for devices | Reference code | Catalog number | Pack.-unit pieces | Weight 1 piece g / oz |
|----------|--------------------------|----------------|-----------------|----------------------|-----------------------------|
| Marker | CT-S without DIP switch | MAR.01 | 1SVR366017R0100 | 10 | 0.19/0.007 |
| Marker | CT-S with DIP switch | MAR.02 | 1SVR430043R0000 | 10 | 0.13/0.005 |
| Marker | CT-S.S/P with DIP switch | MAR.12 | 1SVR730006R0000 | 10 | 0.152/0.335 |

¹⁾ also available for CT-S.S/P

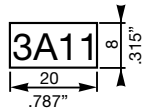

MAR.01

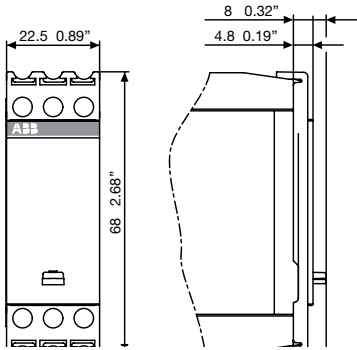

COV.11

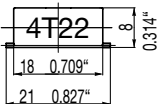

MAR.02